

Article number: 20479B1230

Description: E+G Sensor holders - GN 479-B12-30

Measures

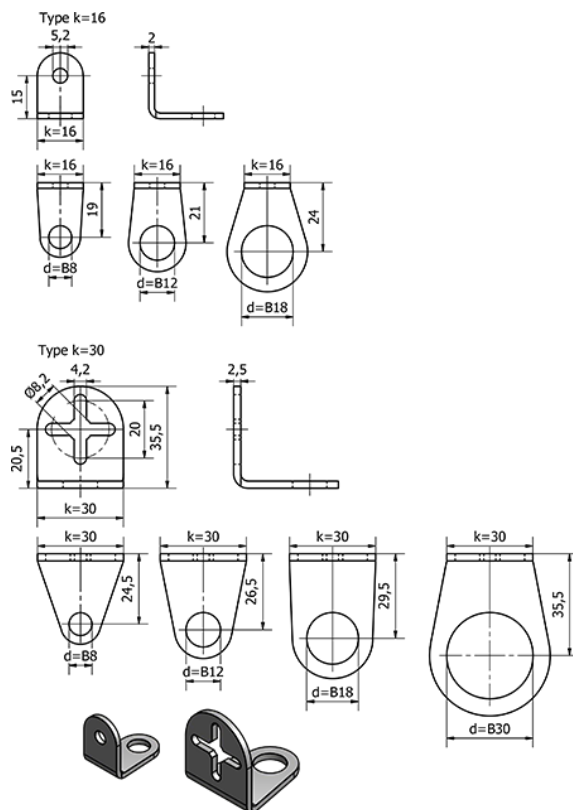

d = 12

k = 30

Weight (g) = 26